

MODELS 710-711

A three-part conference unit with two folding wing panels which close to form an attractive box frame in wood,

simulated wood or other finishes. Solid-aluminum interior mouldings are available in 3 shades.

The ingenious closing mechanism is activated by solid-aluminum horizontal strap hinges, functionally and

stylishly designed for holding panels under pressure.

A panel-height chalkrail stores brushes and chalk when the unit is closed.

The upper moulding can hold a projection screen. An optional lighting system can be enclosed in a finished casing matching the panels. Flip-charts are also available.

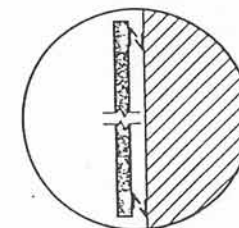
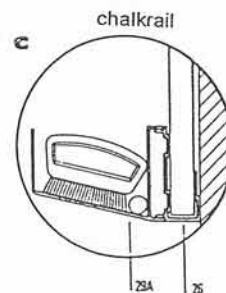
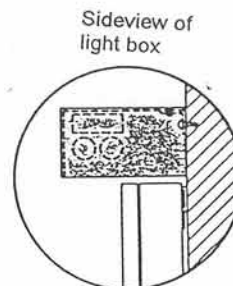
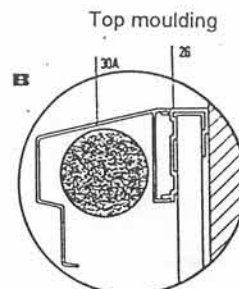
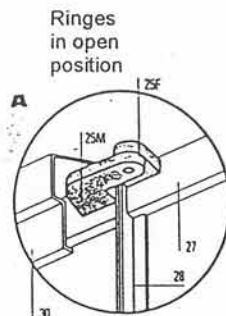
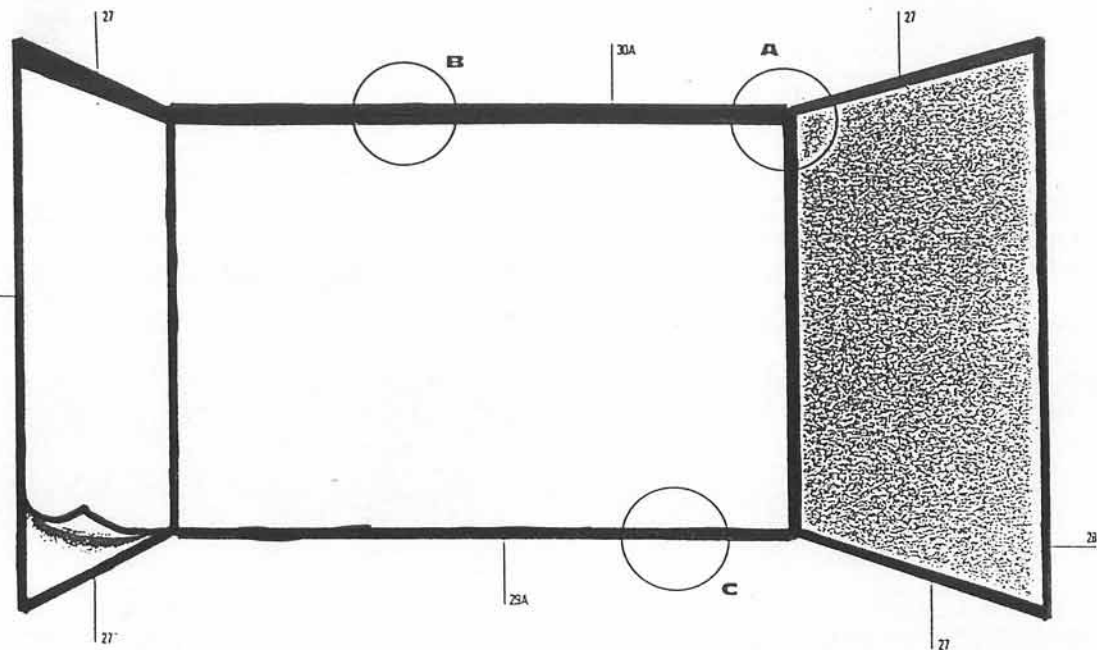

space provided for projection screen installation

attach suspension bar to wall hang board

NOTES:

MODEL 710

MODEL 711

FINISH (WOOD VENEER)

Light oak Medium oak Black oak Mahogany Walnut Other finishes available on request

SIZES

42" X 48" 42" X 60" 42" X 72"

INSTALLATION

ALUMINIUM FRAME

Natural satin Medium bronze Black

DISPLAY SURFACE

Cork Coloured cork Fabric

WRITING SURFACE

Porcelain White steel

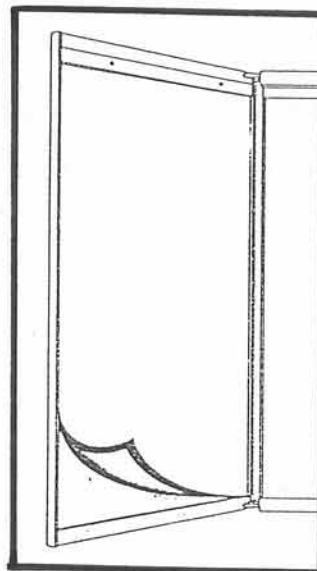

Flip-chart option (25 sheets 24 in. X 36 in.)

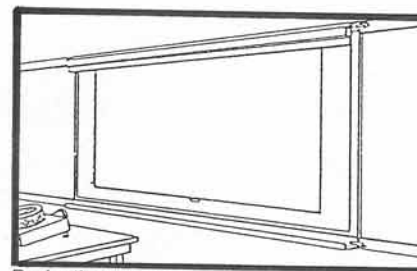

Projection screen option

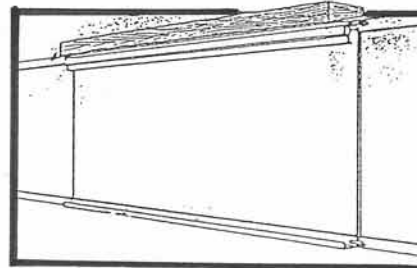

Lighting system option

SPECIFICATIONS:

WRITING BOARD

Lauzonite on "Duracron" iron with a finish according to the BNO 6697-100-101 norms

Porcelain on iron with a finish according to the PEIS-104 finish.

Color _____

TACKBOARDS

"Pernotan" cork

Colored cork

Other

Thickness _____

Color _____

PROJECTION SCREEN

FRAME

Extrusion of aluminum anodized BLACK

Other _____

N.B.



CONTRACTOR: _____

ARCHITECT: _____

PROJECT: _____

ADDRESS: _____

DATE: _____

OF